

**Lemi**<sup>®</sup>  
ITALIAN WELLNESS EQUIPMENT



WATER

*The WATER line includes unique up-to-date spa equipment specific for Spa treatments with water, steam bath, hydrotherapy treatments, massages, professional manicure and pedicure.*

La linea WATER include delle attrezzature spa che presentano una tecnologia avanzata specifica per trattamenti Spa con acqua, bagni di vapore, trattamenti di idroterapia, massaggi, manicure e pedicure professionale.

WATER

# PEDI SPA ECO

PEDI SPA ECO



## COD. 121 ECO

*Pedi Spa ECO is the entry-level pedicure station with an integrated professional hydromassage, thanks to the 4 lateral jets. The chair is completely adjustable and the oval shaped tub allows the practitioner to easily work in front of the client and on each side of the tub.*

*IDEAL FOR: spa manicure and spa pedicure, facial treatments.*

Pedi Spa è la postazione pedicure high-level con sistema di idromassaggio professionale integrato grazie a 4 getti plantari e 6 getti laterali, per un completo trattamento spa pedicure. La poltrona è completamente regolabile e la forma ovale della vasca permette all'operatore di lavorare facilmente di fronte al cliente e su ogni lato della vasca.

IDEALE PER: spa manicure e spa pedicure, trattamenti viso.

*\* The images are for illustrative purposes only and may not reflect the actual image of the finishing.*

*\* Le immagini hanno valore puramente illustrativo e possono non rispecchiare l'immagine reale della finitura.*

\* B: Bianco | M: Nefos 6

Version with Memory Foam mattress / Versione con materasso Memory Foam

## Focus on

- 4 lateral jets for a professional hydromassage
- Manual seat sliding adjustment
- 180° manual chair rotation
- Backrest with gas-spring adjustment
- Manually adjustable footrest
- Wide armrests with manicure bowls
- Perfect for pedicure, manicure and facial treatments

- 4 getti laterali per un idromassaggio professionale
- Scorrimento manuale della seduta
- Rotazione manuale della poltrona di 180°
- Schienale regolabile mediante molla a gas
- Poggia piedi regolabile manualmente
- Ampi braccioli con bacinelle manicure
- Perfetta per trattamenti piedi, mani e viso

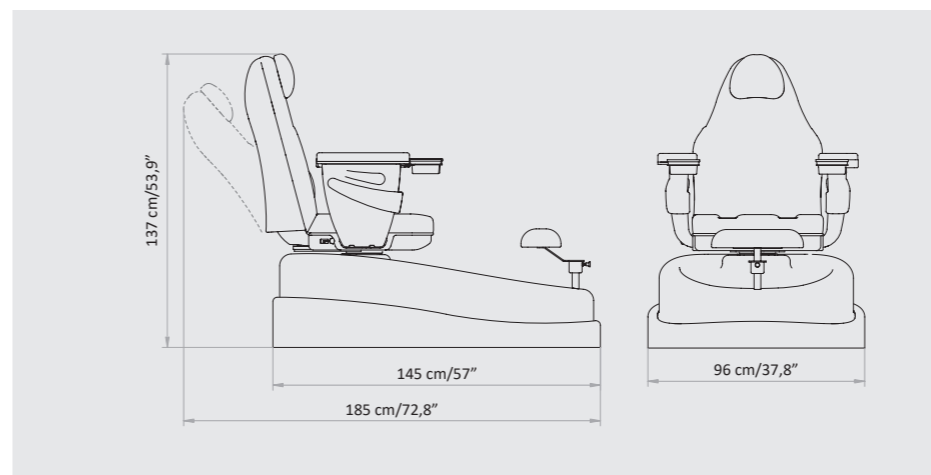

## Packaging details

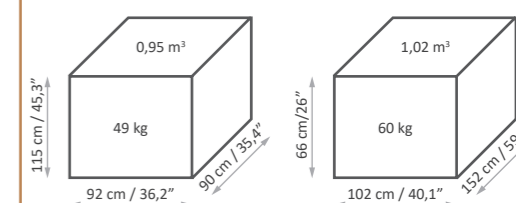

CHAIR / SEDUTA

TUB / VASCA



MAXIMUM CAPACITY  
PORTATA MASSIMA

200 kg

# MATTRESS CUSTOMIZATION PERSONALIZZAZIONE MATERASSO

VITA - COLOR CHART

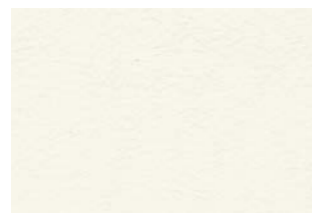

EV00021



EV00022



EV00041



EV00042

SPA PRESTIGE - COLOR CHART



9916

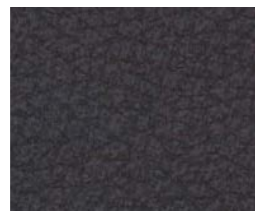

1424

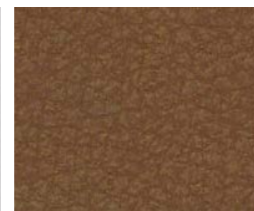

1423

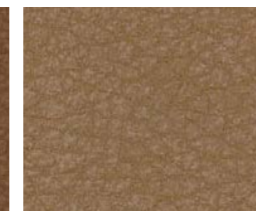

1422

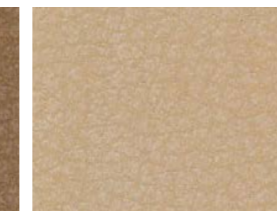

2202



2204



7022



7023



1875

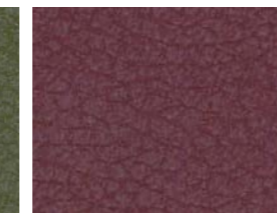

1530

NEFOS - COLOR CHART

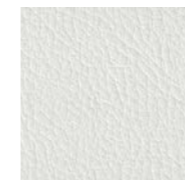

6



1957



6985



3962

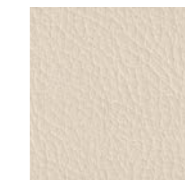

1155

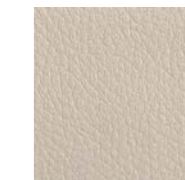

2124



1194

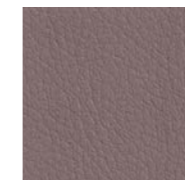

2173



6986



569



667



680



64



71

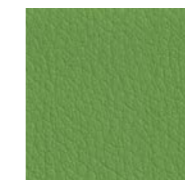

1868

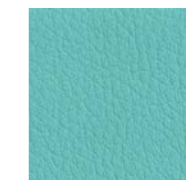

1843

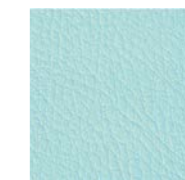

8019

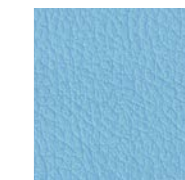

8009



5946



6940



6941



6942



1388

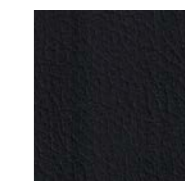

991

The images are for illustrative purposes only and may not reflect the actual finish of the product, particularly when viewed through a screen. Therefore, the **SELECTION OF THE FINISHES** of the **BASES** and **MATTRESS FABRICS** must take place **AFTER CONSULTING** the **LUXURY BOX PHYSICAL SAMPLES** and the **COLOR CHARTS**.

The innovative VITA (consisting of 80% natural and renewable components), Spa Prestige and Nefos materials - which are exclusive for LEMI products - and their special finishing touch guarantee easy-cleaning and hygiene. Their extraordinary structural qualities will persist through the years. An incredibly elastic texture enhances the memory foam mattress softness and quality at its best, giving Spa Clients a complete and satisfying wellness experience.

Gli innovativi materiali VITA (costituiti per l'80% da componenti naturali e rinnovabili), Spa Prestige e Nefos - che sono un'esclusiva dei prodotti LEMI - ed il loro speciale tocco di finitura garantiscono una facile pulizia e igiene. Le loro straordinarie qualità strutturali permangono nel corso degli anni. Una texture incredibilmente elastica migliora al massimo la morbidezza e la qualità del materasso in Memory Foam, dando ai clienti Spa un'esperienza di benessere completa e soddisfacente.

Le immagini hanno valore puramente illustrativo e possono non rispecchiare la finitura reale del prodotto, in particolare se visualizzate attraverso uno schermo. Pertanto la **SELEZIONE DELLE FINITURE** delle **BASI** e dei **RIVESTIMENTI** dei **MATERASSI** deve avvenire **PREVIA CONSULTAZIONE** della **CAMPIONATURA FISICA** della **LUXURY BOX** e delle **CARTELLE COLORI**.

# THERMOFORMED ABS BASE BASE ABS TERMOFORMATO

## ABS FINISHES



White  
Bianco

We provide a thermoformed ABS base, reinforced with fiberglass. The result is a very robust material that is scratch resistant and easy to clean.

Forniamo una base in ABS termoformato, irrobustito da vetroresina. Il risultato è un materiale molto robusto, resistente ai graffi e facile da pulire.

The images are for illustrative purposes only and may not reflect the actual finish of the product, particularly when viewed through a screen. Therefore, the **SELECTION OF THE FINISHES** of the **BASES** and **MATTRESS FABRICS** must take place **AFTER CONSULTING** the **LUXURY BOX PHYSICAL SAMPLES** and the **COLOR CHARTS**.

Le immagini hanno valore puramente illustrativo e possono non rispecchiare la finitura reale del prodotto, in particolare se visualizzate attraverso uno schermo. Pertanto la **SELEZIONE DELLE FINITURE** delle **BASI** e dei **RIVESTIMENTI** dei **MATERASSI** deve avvenire **PREVIA CONSULTAZIONE** della **CAMPIONATURA FISICA** della **LUXURY BOX** e delle **CARTELLE COLORI**.

# ACCESSORIES UPON REQUEST ACCESSORI SU RICHIESTA

All tables have a standard setting customizable upon request.

Tutti i lettini hanno una configurazione standard personalizzabile su richiesta.



Arm support  
Appoggiaabbraccia

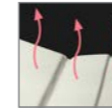

Heating system  
Riscaldamento



Customized mattress with logo  
Personalizzazione materasso con logo



Extra comfort mattress with Memory Foam 15cm  
Materasso extra comfort con Memory Foam 15cm

**KIT  
DRAIN**

Wall mounted drain pump  
Kit scarico parete

**GO  
KAL**

Sanitizer  
Detergente

**SANI  
GUEST**

Sanitizer  
Detergente

**KIT  
DRAIN**

Sanitizer  
Detergente

# TECHNICAL REQUIREMENTS

## CARATTERISTICHE TECNICHE

ABSORPTION ASSORBIMENTO	VOLTAGE VOLTAGGIO	POWER POTENZA	FREQUENCY FREQUENZA	WARRANTY	GARANZIA
2,4 Amax	230 Vac	552W	50/60 Hz	<i>Heating: 1 year</i> <i>Electric parts and controls: 2 years</i> <i>Undeformable foam: 5 years</i> <i>Structure: 10 years</i>	Riscaldamento materasso: 1 anno Parti elettriche e comandi: 2 anni Gomma indeformabile: 5 anni Struttura: 10 anni

### REGULATIONS

All Equipment is  marked

#### Electrical equipment and beds

Directive 2006/42/CE (Machinery Directive) and national regulations

Directive 2014/30/UE (Electromagnetic Compatibility Directive) and national regulations.

#### Images

The images are for illustrative purposes only and may not reflect the actual image of the product.

### NORME

Tutte le attrezzature sono a marchio 

#### Attrezzature e lettini elettrici

Direttiva 2006/42/CE (Direttiva Macchine) e disposizioni nazionali di attuazione

Direttiva 2014/30/UE (Direttiva Compatibilità elettromagnetica) e disposizioni nazionali di attuazione.

#### Immagini

Le immagini hanno valore puramente illustrativo e possono non rispecchiare l'immagine reale del prodotto.

**Lemi**<sup>®</sup>  
ITALIAN WELLNESS EQUIPMENT

#### Brusaferrì & C srl

Via Mara Maretti Soldi, 13  
26011 Casalbuttano (CREMONA) ITALY  
Phone +39-0374-363069 Fax +39-0374-363071  
info@lemigroup.it service@lemigroup.it

www.lemigroup.it