

Work happily



V1.2

naggura'swop

naggura.com

Our products



Massage

Swop 2L Massage

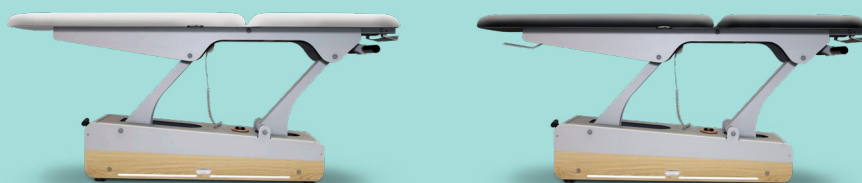

Swop 2L Massage is an all-round
electrical treatment table!
Simply multipurpose!

Wood, Metal or Pmma



Collections

Nordic METAL

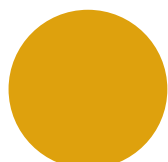

Yellow

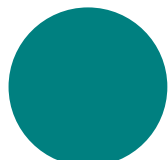

Blue

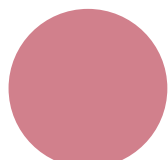

Pink

Foll METAL

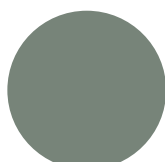

Ash

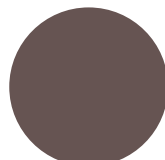

Clay

Iron METAL

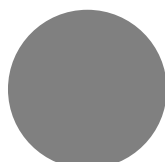

Inox

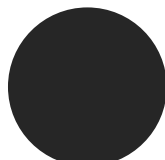

Black

Om WOOD



Oak



Wenge

Techno PMMA



Fluor



Fuxia



Ice

SWOP 2L MASSAGE



Dimensions

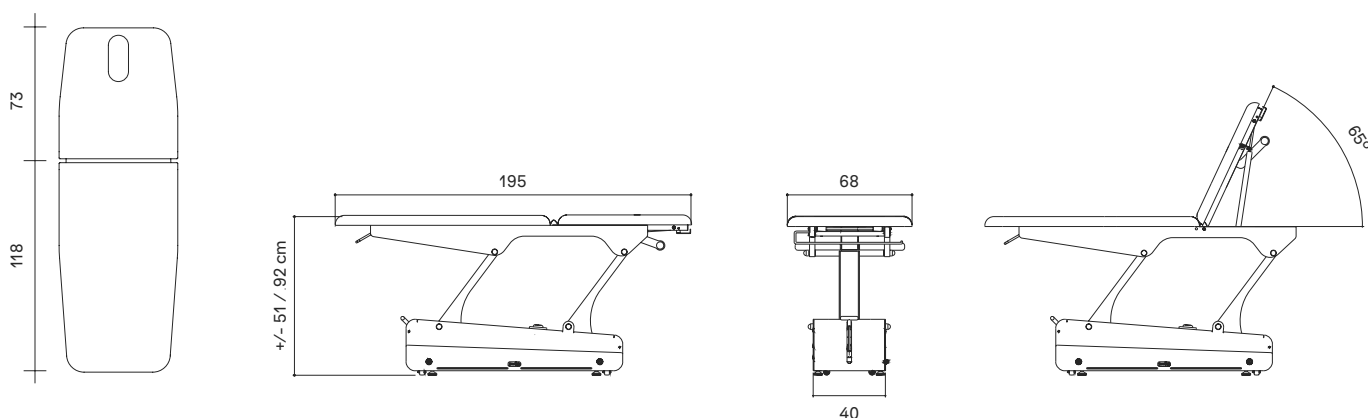

General Specifications

MOTORS

1 engine (height)

DIMENSIONS (LENGTH X WIDTH)

195 x 68 cm

HEIGHT (MIN. AND MAX.)

51/92 cm

WEIGHT

92 kg

THICKNESS

6 cm

DENSITY

40 kg/m³

LIFTING CAPACITY

200 kg

OPERATION

Hand controller (included)/
Foot controller (optional)

POWER SUPPLY

230 V - 50/60 Hz

MAX. INTENSITY

2 A

ELECTRIC MOTOR

6.000 N

CUSHION

Seamless Upholstery and
round edges.

Naggura Skin upholstery:
100% vinyl compound in
white or grey.

Superior abrasion resis-
tance: >250.000 cycles.
Protection against germs
and UV rays.